

EX30 Bodykit Lackiertabelle / *Paint-job-overview*



Warnung / *Warning*

Die Bauteile sind spannungsfrei zu bearbeiten und zu lagern! Achten Sie auch bei thermischer Behandlung darauf, dass sich die Bauteile nicht verformen. /

The parts must be processed and stored stress-free! Ensure that the components are not deformed, even during thermal treatment.

Bitte ankreuzen / *Please mark:*

Wagenfarbe / <i>car colour</i>	Farbcode / <i>colour code</i>	✘
Cloud Blue		
Moss Yellow		
Onyx Black		
Vapour Grey		
Crystal White		

Lackierumfang / *Scope of paint job*

HEICO Art.Nr.	Name	✘
H8915371	Gesamtes Bodykit / <i>Full Bodykit</i>	
H8915364	Design Lufteinlass / <i>Design air intake</i>	
H8915363	Frontspoiler	
H8915369	Diffusor	

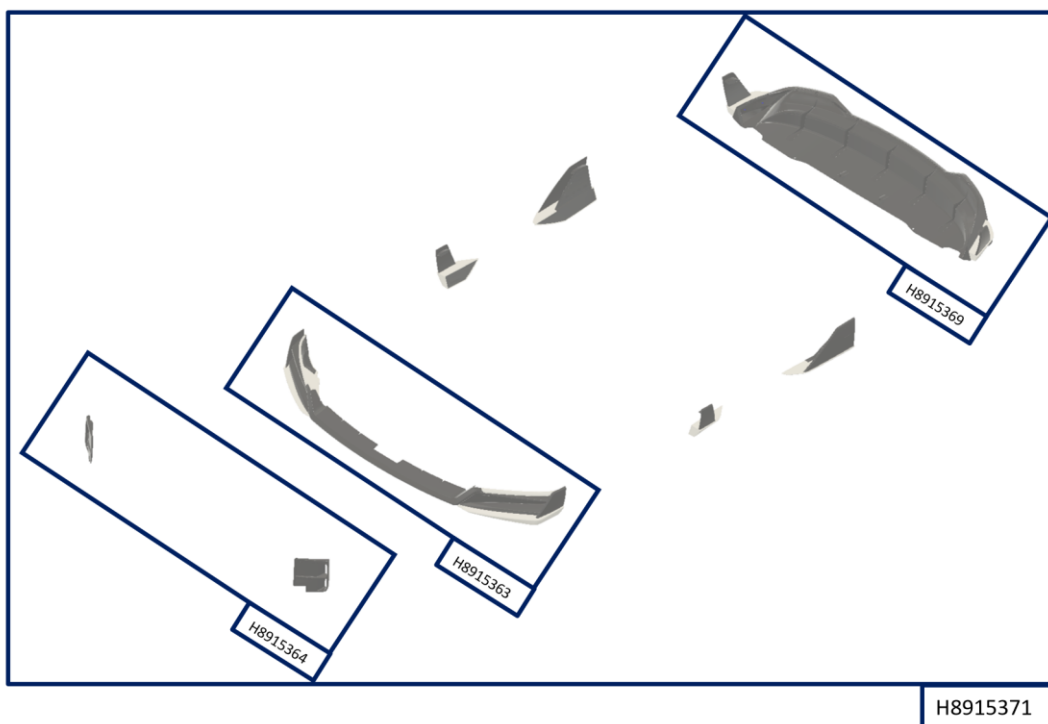

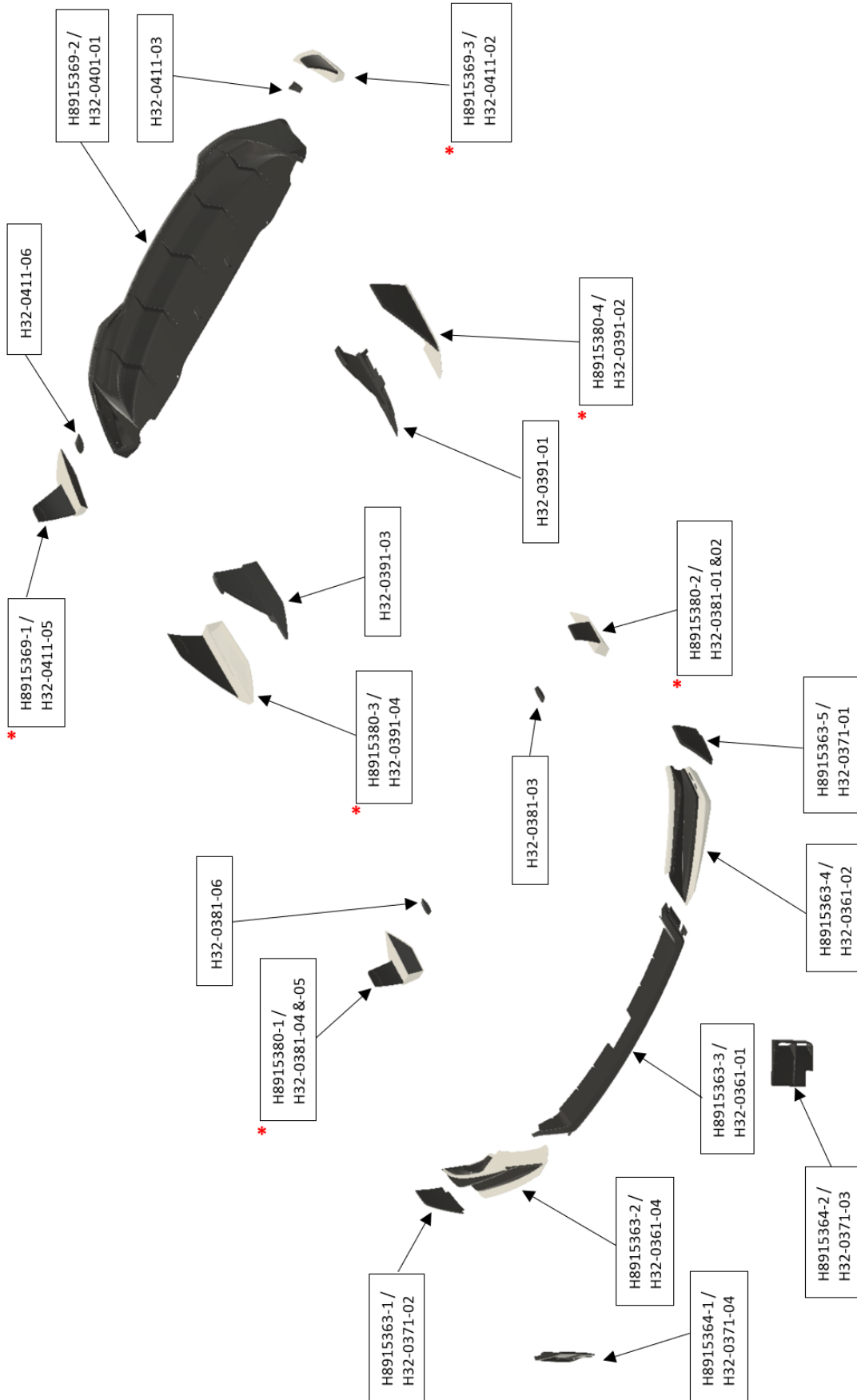

*Für saubere Trennkanten und verringerten Arbeitsaufwand empfiehlt es sich, eine Folierung für die Winglets zu verwenden, nachdem die untere Bauteilhälfte lackiert wurde. /
 *For clean separation lines and reduced labor, it is recommended to use a foilation for the winglets after the lower half of the component has been painted.

Frontspoiler

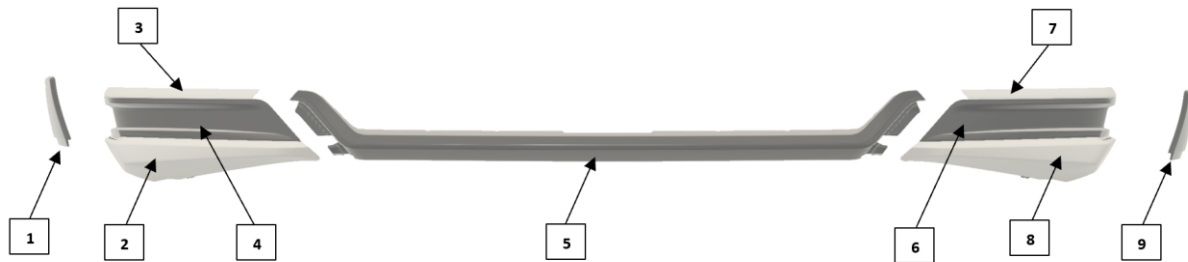

#	HEICO Art.Nr.	Farbe / Colour
1	H8915363-1	Piano Black
2	H8915363-2	Wagenfarbe / <i>car colour</i>
3		Wagenfarbe / <i>car colour</i>
4		Piano Black
5	H8915363-3	Piano Black
6	H8915363-4	Piano Black
7		Wagenfarbe / <i>car colour</i>
8		Wagenfarbe / <i>car colour</i>
9	H8915363-5	Piano Black

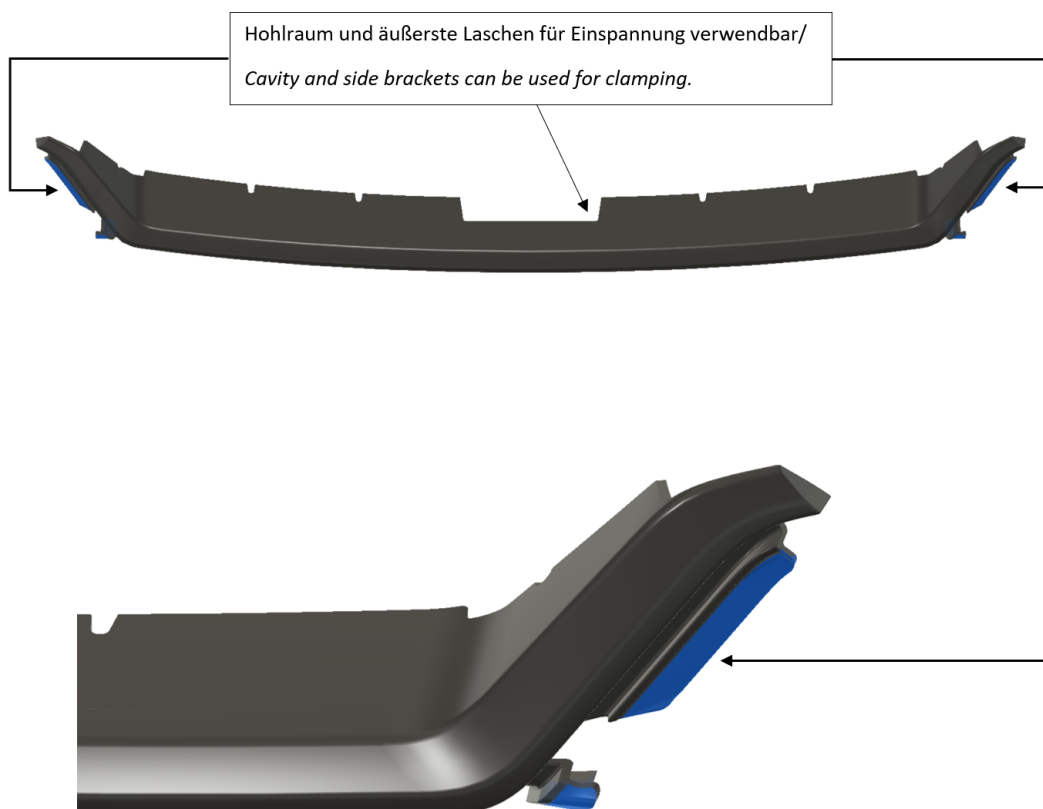

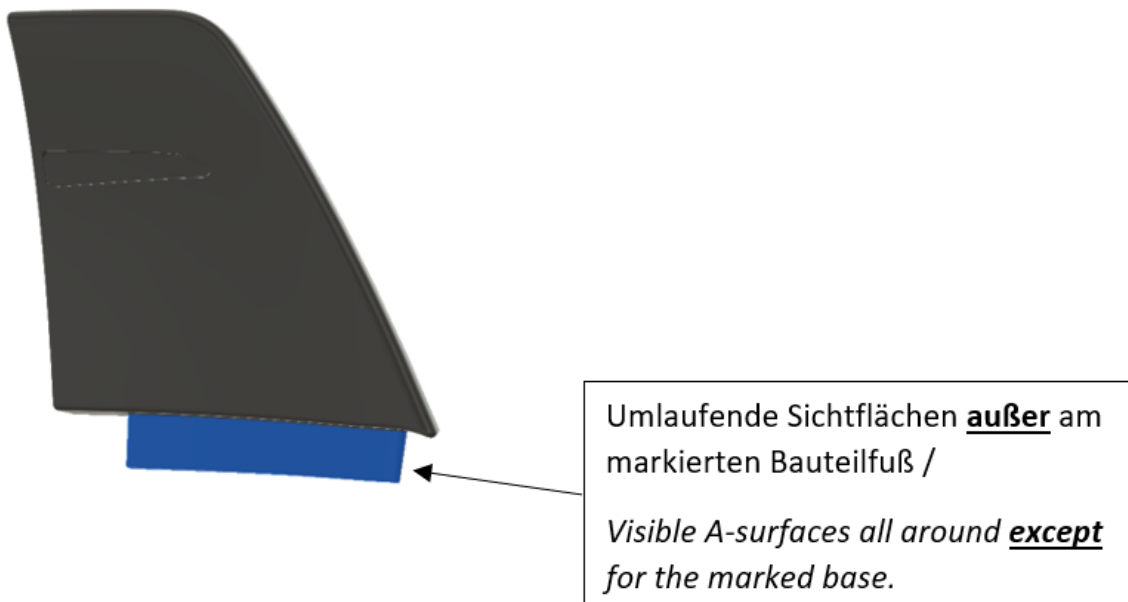
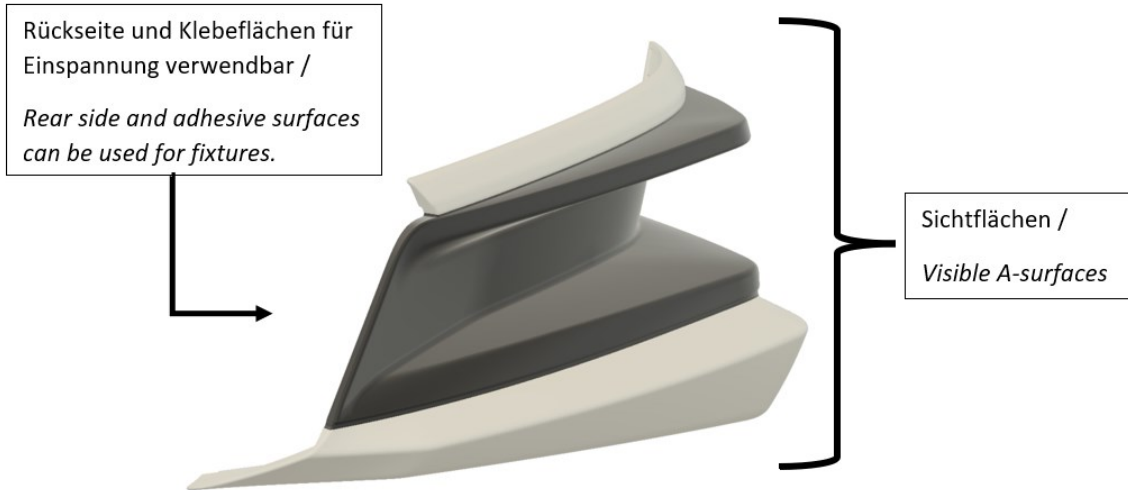

Design Lufteinlass / Design air intake

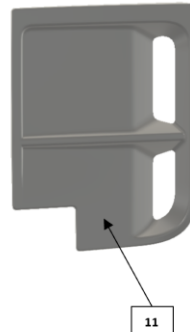
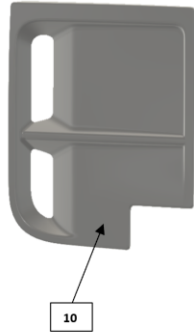

#	HEICO Art.Nr.	Farbe / Colour
10	H8915364-R	Piano Black
11	H8915364-L	Piano Black

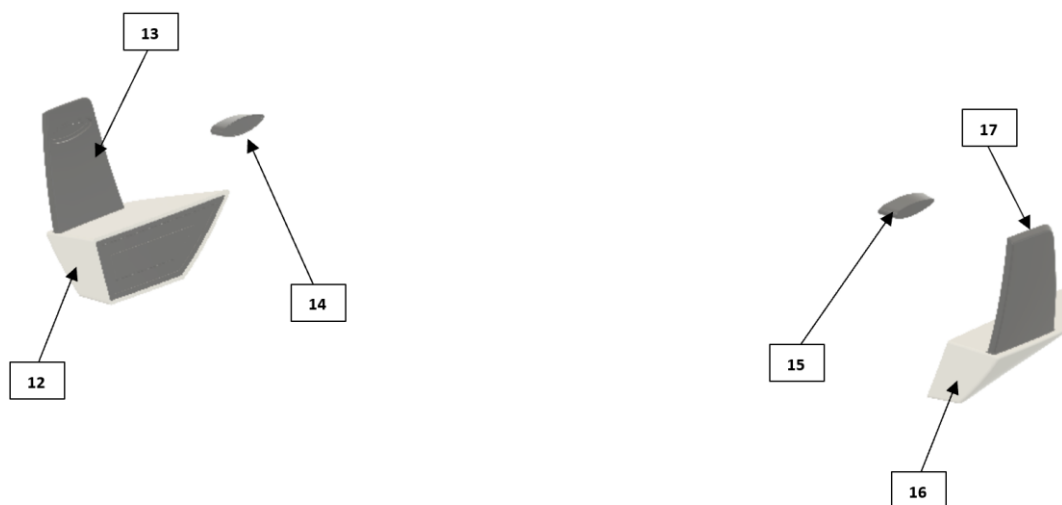
Vorderes Seitenschweller-Winglet / Front side skirt winglet

#	HEICO Art.Nr.	Farbe / Colour
12	H8915371-1-R	Wagenfarbe / <i>car colour</i>
13		Piano Black
14	H8915371-2-R	Piano Black
15	H8915371-2-L	Piano Black
16	H8915371-1-L	Wagenfarbe / <i>car colour</i>
17		Piano Black

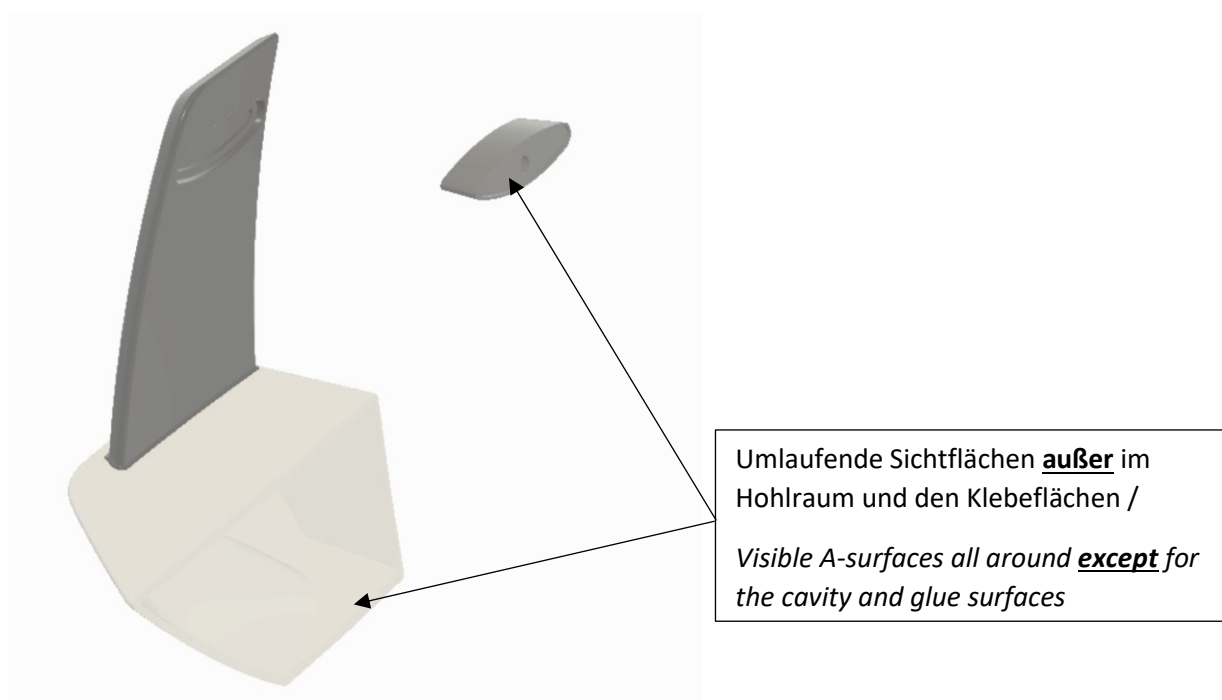

Hinteres Seitenschweller-Winglet / *Rear side skirt winglet*

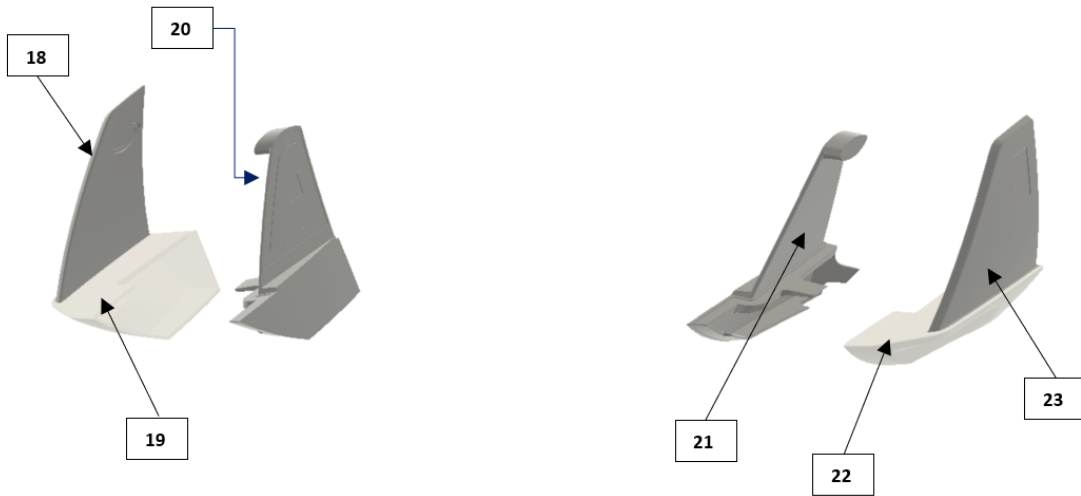

#	HEICO Art.Nr.	Farbe / <i>Colour</i>
18	H8915371-3-R	Piano Black
19		Wagenfarbe / <i>car colour</i>
20	H8915371-4-R	Piano Black
21	H8915371-4-L	Piano Black
22	H8915371-3-L	Wagenfarbe / <i>car colour</i>
23		Piano Black

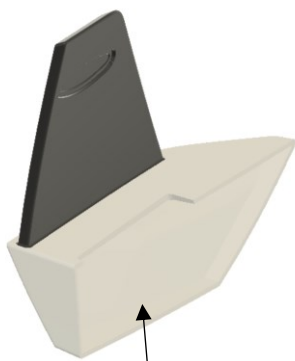

Umlaufende Sichtflächen **außer** im Hohlraum /
*Visible A-surfaces all around **except** for the cavity*

Sichtflächen: Nur ovaler Steg und darunterliegende Anschraubfläche /
Visible A-surfaces: only the oval bridge and mounting surface directly below

Visible A-surfaces: only the oval bridge and mounting surface directly below

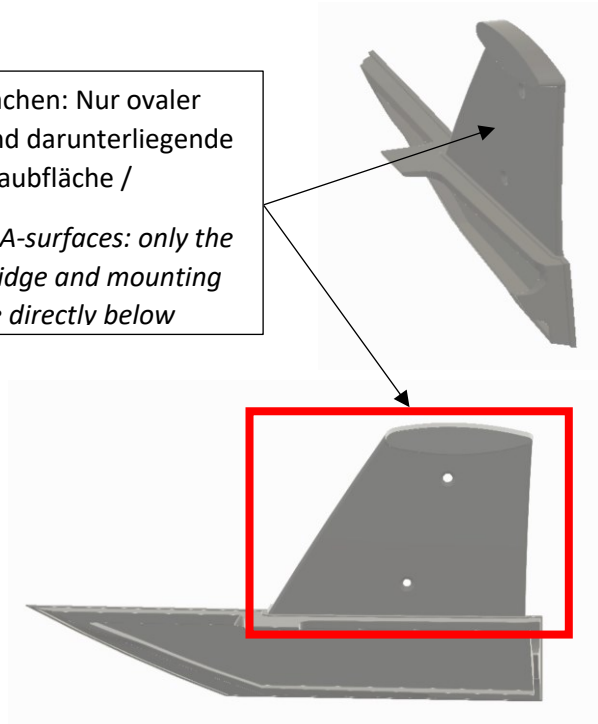

Diffusor

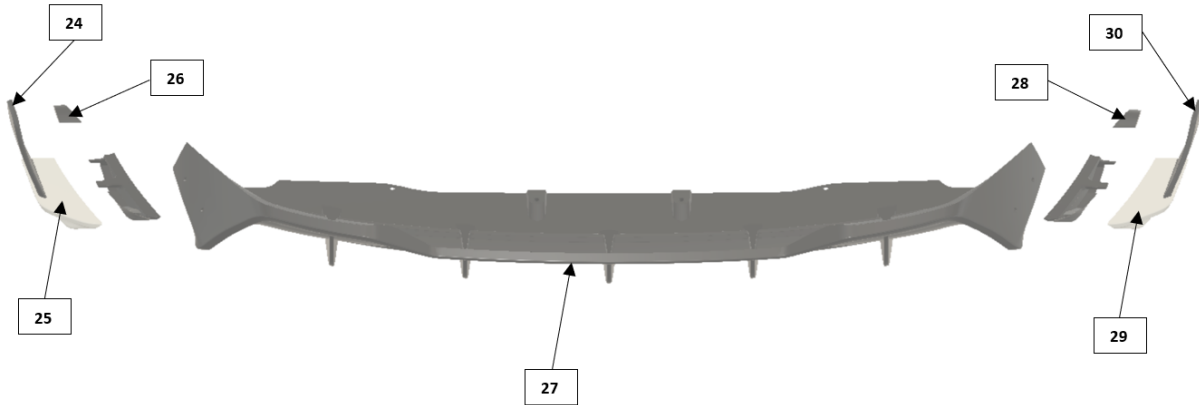

#	HEICO Art.Nr.	Farbe / Colour
24	H8915369-5	Piano Black
25		Wagenfarbe / <i>car colour</i>
26	H8915369-4	Piano Black
27	H8915369-3	Piano Black
28	H8915369-2	Piano Black
29	H8915369-1	Wagenfarbe / <i>car colour</i>
30		Piano Black

